

Art.-Nr.: 10.13.04.00906

**Technical data**

Weight	96.60 g
Number of folds	3.0
Length L	32.00 mm
Width B	45.00 mm
Height H	84.30 mm
Thread G1	G1/8"-F
Thread length LG1	8.0 mm
Thread G2	M4-F
Thread length LG2	8.0 mm
Shape	Compact
Application	Basic
Finger element	Module

FINGER-MODULE-3C-B-AL-SI-FOOD

The finger module FINGER-MODULE-B is delivered assembled. The product consists of:

- Finger module adapter (FINGER-COMP-BASE), available in aluminum and stainless steel version
- Finger module spare unit (FINGER-SPARE-UNIT-B), available with material for general industrial applications and with suitable material for food contact
- Sealing screws (VRS-SB), available with suitable material for food contact

Available spare parts: finger module spare unit, finger module adapter, sealing screw

Available accessories: plug-in screw union, mounting element Sliding Clamp

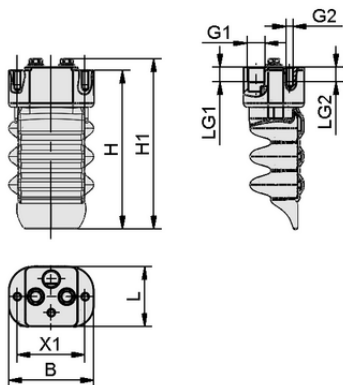
**Design data**

Length L	32.00 mm
Width B	45.00 mm
Height H1	90.40 mm
Height H	84.30 mm
Thread G1	G1/8"-F
Thread length LG1	8.0 mm
Thread G2	M4-F
Thread length LG2	8.0 mm
Hole spacing X1	36.0 mm

Design data FINGER-MODULE-3C-B-AL-SI-FOOD



Art.-Nr.: 10.13.04.00906

**Technical data**

Suction cup material	Silicone SI
Number of folds	3.0
Nipple material	Aluminum
Material characteristics	for food contact
Shape	Compact

**Ordering Data Accessories 10.13.04.00906**

Typ		Item number
Finger module component mGrip	FINGER-COMP BASE A4 HYG	10.13.03.04090
Machine screw	SCHR 4762 M4x10 A2	20.01.02.00267
Accessories mGrip	ACCS-mGrip CLAMP-FB IND 4.5	10.13.03.04091
Knurled screw	SCHR M4 A2	10.13.03.04199
Plug union, straight	STV-GE G1/8-AG 6	10.08.02.00204
Plug union, elbow	STV-W G1/8-AG 6	10.08.02.00288

**Ordering Data Spare Parts 10.13.04.00906**

Typ		Item number
Finger module spare unit mGrip	FINGER-SPARE-UNIT 3C HYG	10.13.04.00593
Finger module component mGrip	FINGER-COMP-SET BASE IND	10.13.04.00590

