

Bell suction cup (round)

SAX 60 ED-85 G3/8-AG



Art.-Nr.: 10.01.19.00357



Technical data

Attribute	Value
Suction cup material	Elastodur ED
Material hardness [Shore A]	85.0 Shore A
Size	60.00
Number of folds	0.0
Connection	G3/8"-M

SAX 60 ED-85 G3/8-AG

Suction cup SAX, available in various diameters, is delivered with connection nipple vulcanized to elastomer part.

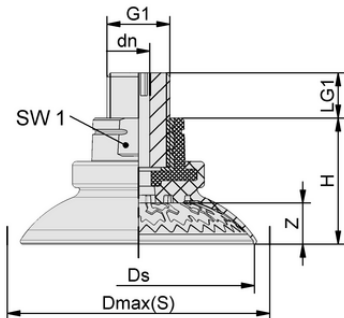

Design data

Attribute	Value
Height H	33.40 mm
Nominal diameter dn	6.10 mm
Thread G1	G3/8"-M
Thread length LG1	12.0 mm
Key width SW1	22.0 mm
Spring stroke Z	10.9 mm
Diameter Ds	61.5 mm
Diameter Dmax(S)	69.7 mm

Design data SAX 60 ED-85 G3/8-AG



WWW.SCHMALZ.COM/10.01.19.00357

Bell suction cup (round)

SAX 60 ED-85 G3/8-AG



Art.-Nr.: 10.01.19.00357



Technical data

Attribute	Value
Suction cup material	Elastodur ED
Material hardness [Shore A]	85.0 Shore A
Workpiece radius min. (convex)	30.0 mm
Suction force (-600mbar)	154.00 N
Weight	35.00 g
Lateral force	107.0 N
Lateral force oily surface	155.0 N
Volume	25.200 cm ³
Size	60.00
Number of folds	0.0
Connection	G3/8"-M
Product family	SAX

Note: Suction force: The suction force values are theoretical values at -0.6 bar vacuum and a dry, smooth and even workpiece surface – they are specified without safety factors. Hose inner diameter: The recommended hose diameter refers to a hose length of approx. 2 m



Further documentation

CAD data and other documents relating to the article can be found at: www.schmalz.com/10.01.19.00357



WWW.SCHMALZ.COM/10.01.19.00357