

Bell suction cup (round)

SAX 30 ED-85 G1/4-AG



Art.-Nr.: 10.01.19.00335



Technical data

Attribute	Value
Suction cup material	Elastodur ED
Material hardness [Shore A]	85.0 Shore A
Size	30.00
Number of folds	0.0
Connection	G1/4"-M

SAX 30 ED-85 G1/4-AG

Suction cup SAX, available in various diameters, is delivered with connection nipple vulcanized to elastomer part.

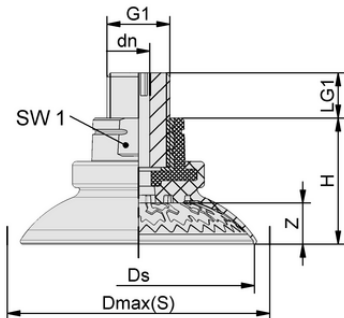

Design data

Attribute	Value
Height H	26.00 mm
Nominal diameter dn	6.10 mm
Thread G1	G1/4"-M
Thread length LG1	14.0 mm
Key width SW1	22.0 mm
Spring stroke Z	4.5 mm
Diameter Ds	31.7 mm
Diameter Dmax(S)	35.2 mm

Design data SAX 30 ED-85 G1/4-AG



WWW.SCHMALZ.COM/10.01.19.00335

1

Bell suction cup (round)

SAX 30 ED-85 G1/4-AG



Art.-Nr.: 10.01.19.00335



Technical data

Attribute	Value
Suction cup material	Elastodur ED
Material hardness [Shore A]	85.0 Shore A
Workpiece radius min. (convex)	18.0 mm
Suction force (-600mbar)	39.00 N
Weight	32.50 g
Lateral force	38.0 N
Lateral force oily surface	41.0 N
Volume	3.200 cm ³
Size	30.00
Number of folds	0.0
Connection	G1/4"-M
Product family	SAX

Note: Suction force: The suction force values are theoretical values at -0.6 bar vacuum and a dry, smooth and even workpiece surface – they are specified without safety factors. Hose inner diameter: The recommended hose diameter refers to a hose length of approx. 2 m



Further documentation

CAD data and other documents relating to the article can be found at: www.schmalz.com/10.01.19.00335



WWW.SCHMALZ.COM/10.01.19.00335