

Çan vantuz (yuvarlak)

# SAX 100 ED-85 M16-AG RP



Art.-Nr.: 10.01.19.00234



## Teknik veriler

Attribute	Value
Vantuz malzemesi	Elastodur ED
Malzeme sertliği [Shore A]	85,0 Shore A
Boyut	100,00
Körük Sayısı	0,0
Bağlantı	M16-M

SAX 100 ED-85 M16-AG RP

Çeşitli çaplarda mevcut olan SAX vantuz, elastomer parçaya vulkanize edilmiş bağlantı nipeli ile birlikte teslim edilir.

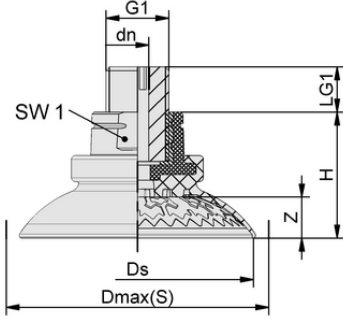

## Tasarım verileri

Attribute	Value
Yükseklik H	39,70 mm
Nominal çap dn	6,10 mm
Diş G1	M16-M
Diş uzunluğu LG1	12,0 mm
Anahtar boyutu SW1	22,0 mm
Yay stroku Z	17,3 mm
Çap Ds	100,1 mm
Çap Dmax(S)	111,1 mm

Tasarım verileri SAX 100 ED-85 M16-AG RP



[WWW.SCHMALZ.COM/10.01.19.00234](http://WWW.SCHMALZ.COM/10.01.19.00234)

1

Çan vantuz (yuvarlak)

## SAX 100 ED-85 M16-AG RP



Art.-Nr.: 10.01.19.00234



### Teknik veriler

Attribute	Value
Vantuz malzemesi	Elastodur ED
Malzeme sertliği [Shore A]	85,0 Shore A
İş parçası yarıçapı dak (dışbükey)	40,0 mm
Emme kuvveti (-600mbar)	412,00 N
Ağırlık	62,50 g
Yanal kuvvet	284,0 N
Yanal kuvvet yağlı yüzey	414,0 N
Cilt	96,000 cm <sup>3</sup>
Boyut	100,00
Körük Sayısı	0,0
Bağlantı	M16-M
Ürün ailesi	SAX

Note: Suction force: The suction force values are theoretical values at -0.6 bar vacuum and a dry, smooth and even workpiece surface – they are specified without safety factors. Hose inner diameter: The recommended hose diameter refers to a hose length of approx. 2 m



### Further documentation

CAD data and other documents relating to the article can be found at: [www.schmalz.com/10.01.19.00234](http://www.schmalz.com/10.01.19.00234)



### Discontinued item

The product family will be discontinued and is available until **31.12.2026**  
Starting from this time, the article can no longer be ordered.  
alternative article



[WWW.SCHMALZ.COM/10.01.19.00234](http://WWW.SCHMALZ.COM/10.01.19.00234)