

Çan vantuz (yuvarlak)

SAX 40 ED-85 M16-AG RP



Art.-Nr.: 10.01.19.00230



Teknik veriler

Attribute	Value
Vantuz malzemesi	Elastodur ED
Malzeme sertliği [Shore A]	85,0 Shore A
Boyut	40,00
Körük Sayısı	0,0
Bağlantı	M16-M

SAX 40 ED-85 M16-AG RP

Çeşitli çaplarda mevcut olan SAX vantuz, elastomer parçaya vulkanize edilmiş bağlantı nipeli ile birlikte teslim edilir.

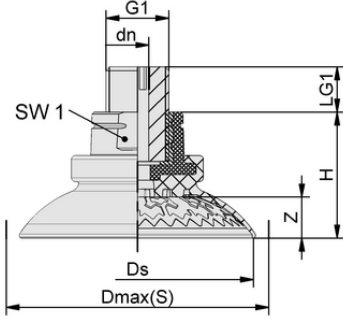

Tasarım verileri

Attribute	Value
Yükseklik H	29,30 mm
Nominal çap dn	6,10 mm
Diş G1	M16-M
Diş uzunluğu LG1	12,0 mm
Anahtar boyutu SW1	22,0 mm
Yay stroku Z	7,1 mm
Çap Ds	41,3 mm
Çap Dmax(S)	45,4 mm

Tasarım verileri SAX 40 ED-85 M16-AG RP



WWW.SCHMALZ.COM/10.01.19.00230

1

Art.-Nr.: 10.01.19.00230

**Teknik veriler**

Attribute	Value
Vantuz malzemesi	Elastodur ED
Malzeme sertliği [Shore A]	85,0 Shore A
İş parçası yarıçapı dak (dışbükey)	25,0 mm
Emme kuvveti (-600mbar)	69,00 N
Ağırlık	36,50 g
Yanal kuvvet	49,0 N
Yanal kuvvet yağlı yüzey	71,0 N
Cilt	8,500 cm ³
Boyut	40,00
Körük Sayısı	0,0
Bağlantı	M16-M
Ürün ailesi	SAX

Note: Suction force: The suction force values are theoretical values at -0.6 bar vacuum and a dry, smooth and even workpiece surface – they are specified without safety factors. Hose inner diameter: The recommended hose diameter refers to a hose length of approx. 2 m

**Further documentation**

CAD data and other documents relating to the article can be found at: www.schmalz.com/10.01.19.00230

**Discontinued item**

The product family will be discontinued and is available until **31.12.2026**
Starting from this time, the article can no longer be ordered.
alternative article

