



Technical data

Suction cup material	Elastodur ED
Material hardness [Shore A]	85.0 Shore A
Size	50.00
Connection	M14x1.5-AG
Nipple material	Aluminum

SAXM 50 ED-85 M14x1.5-AG

Bell-shaped suction cup SAXM (elastomer part + connection element) is delivered assembled. As an alternative the individual parts can also be ordered separately. To do this, the following ordering steps are required:

- Bell-shaped suction cup of type SAXM (step 1) – elastomer part, available in various diameters
- Connector upper part (step 2) – available with various threads
- Connector lower part (step 3) – including molded friction disc

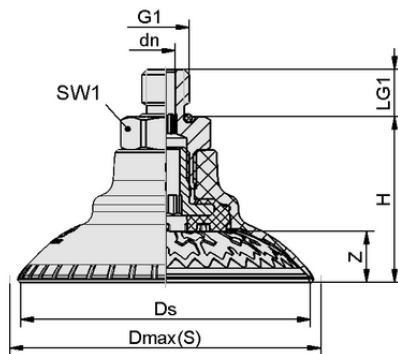

Design data

Height H	32.80 mm
Nominal diameter dn	6.10 mm
Thread G1	M14x1.5-M
Thread length LG1	10.0 mm
Key width SW1	17.0 mm
Spring stroke Z	8.4 mm
Diameter Ds	51.5 mm
Diameter Dmax(S)	58.4 mm

Note: Acceptable dimensional tolerances for elastomer parts concerning to DIN ISO 3302-1 M3

Design data SAXM 50 ED-85 M14x1.5-AG

Art.-Nr.: 10.01.19.00027

**Technical data**

Suction cup material	Elastodur ED
Material hardness [Shore A]	85.0 Shore A
Hose inner diameter (recom.) d	6.0 mm
Workpiece radius min. (convex)	25.0 mm
Suction force (-600mbar)	109.00 N
Weight	28.20 g
Lateral force	58.0 N
Lateral force oily surface	110.0 N
Volume	14.400 cm ³
Size	50.00
Number of folds	0.0
Connection	M14x1.5-M
Product family	SAXM

Note: Suction force: The specified suction forces are theoretical values at a vacuum of -0.6 bar and with a dry, smooth and even workpiece surface - they do not include a safety factor Lateral force: The specified lateral forces are values measured at a vacuum of -0.6 bar with a dry or oily, smooth, flat workpiece surface. Depending on the workpiece surface and its quality, the actual values may deviate from these values Hose diameter: The recommended hose diameter refers to a hose length of approx. 2 m

**Ordering Data Spare Parts 10.01.19.00027**

Typ		Item number
Schmalz-Connector-Adapter	SC-A 055 M14x1.5-AG L	10.01.06.02823

**Ordering Data Wear Parts 10.01.19.00027**

Typ		Item number
Bell suction cup (round)	SAXM 50 ED-85 SC055	10.01.19.00006
Schmalz-Connector-Screw	SC-S 055 FDC-L	10.01.06.02804

