

Bellows suction cup (oval)

## SAOXB 40x20 ED-85 G3/8-IG



Art.-Nr.: 10.01.06.05987



### Technical data

Attribute	Value
Suction cup material	Elastodur ED
Material hardness [Shore A]	85.0 Shore A
Number of folds	1.5
Dimension (LxW)	40x20
Nipple material	Aluminum

SAOXB 40x20 ED-85 G3/8-IG

### Design data

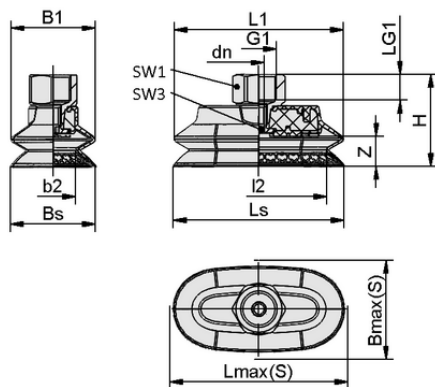

Attribute	Value
Length L1	39.50 mm
Width B1	19.60 mm
Height H	32.50 mm
Nominal diameter dn	4.50 mm
Thread G1	G3/8"-F
Thread length LG1	12.0 mm
Key width SW1	22.0 mm
Spring stroke Z	7.5 mm
Suction cup width Bs	20.00 mm
Ls	40.00 mm
Key width SW3	5.0 mm
Lmax.(S)	43.00 mm
Bmax(S)	24.00 mm
Length L2	29.20 mm
Width B2	9.20 mm

Design data SAOXB 40x20 ED-85 G3/8-IG



[WWW.SCHMALZ.COM/10.01.06.05987](http://WWW.SCHMALZ.COM/10.01.06.05987)

1

Art.-Nr.: 10.01.06.05987

**Technical data**

Attribute	Value
Suction cup material	Elastodur ED
Material hardness [Shore A]	85.0 Shore A
Workpiece radius min. (convex)	8.0 mm
Pull-off force	27.30 N
Suction force (-600mbar)	14.30 N
Lateral force	10.8 N
Lateral force oily surface	14.7 N
Volume	4.600 cm <sup>3</sup>
Number of folds	1.5
Effective suction area	6.67 mm <sup>2</sup>
Product family	SAOXB
Dimension (LxW)	40x20
Nipple material	Aluminum

Note: Suction force: The suction force values are theoretical values at -0.6 bar vacuum and a dry, smooth and even workpiece surface – they are specified without safety factors. Hose inner diameter: The recommended hose diameter refers to a hose length of approx. 2 m

**Further documentation**

CAD data and other documents relating to the article can be found at: [www.schmalz.com/10.01.06.05987](http://www.schmalz.com/10.01.06.05987)

**Ordering Data Spare Parts 10.01.06.05987**

Typ		Item number
Bellows suction cup (oval)	SAOXB 40x20 ED-85 SC042	10.01.06.05780

