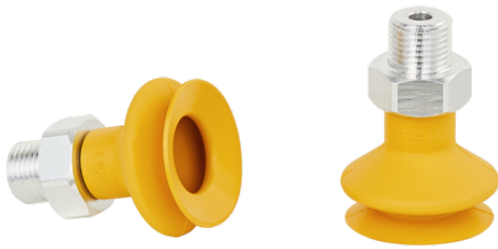

Art.-Nr.: 10.01.06.04483

**Technical data**

Attribute	Value
Suction cup material	Nitrile rubber NBR-ESD
Material hardness [Shore A]	55.0 Shore A
Size	22.00
Number of folds	1.5
Connection	G1/8"-M
Vacuum connection	G1/8"-M
Nipple material	Aluminum

FSGA 22 NBR-ESD-55 G1/8-AG

Suction cup FSGA (elastomer part + connection nipple) is delivered unassembled (diameters of 33 mm and more are assembled). The delivery consists of:

- Suction cup of type FGA – elastomer part, available in various diameters and materials
- Connection nipple of type SA-NIP – available with various threads

Available spare parts: suction cup FGA, connection nipple SA-NIP

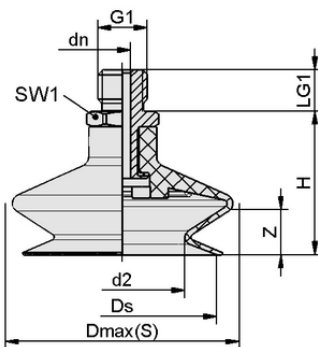

Design data FSGA 22 NBR-ESD-55 G1/8-AG

Design data

Attribute	Value
Height H	25.00 mm
Nominal diameter dn	3.50 mm
d2	11.7 mm
Thread G1	G1/8"-M
Thread length LG1	7.5 mm
Key width SW1	14.0 mm
Spring stroke Z	6.0 mm
Diameter Ds	21.5 mm
Diameter Dmax(S)	25.0 mm

Note: Acceptable dimensional tolerances for elastomer parts concerning to DIN ISO 3302-1 M3



Art.-Nr.: 10.01.06.04483

**Technical data**

Attribute	Value
Suction cup material	Nitrile rubber NBR-ESD
Material hardness [Shore A]	55.0 Shore A
Hose inner diameter (recom.) d	4.0 mm
Workpiece radius min. (convex)	25.0 mm
Pull-off force	15.20 N
Suction force (-600mbar)	5.70 N
Weight	5.80 g
Volume	1.400 cm ³
Size	22.00
Number of folds	1.5
Product family	FSGA
Connection	G1/8-AG

Note: Suction force: The specified suction forces are theoretical values at a vacuum of -0.6 bar and with a dry, smooth and even workpiece surface - they do not include a safety factor Pull-off force: The pull-off force of the versions made of natural rubber is reduced by about 40% Hose diameter: The recommended hose diameter refers to a hose length of approx. 2 m

**Further documentation**

CAD data and other documents relating to the article can be found at: www.schmalz.com/10.01.06.04483

**Ordering Data Spare Parts 10.01.06.04483**

Typ		Item number
Bellows suction cup (round)	FGA 22 NBR-ESD-55 N062	10.01.06.04454
Suction Cup Connection Nipples	SA-NIP N062 G1/8-AG DN350	10.01.06.05670

